



Look A-like Keys with GTI Transponder

Edition
OCTOBER
2014



🇬🇧 SILCA LOOK A-LIKE KEYS RANGE

GTI is compatible with the new Silca Look A-like transponder keys series: a vehicle keys range with key head design identical to the original.

You will be able to easily recognize Silca Look A-like keys range thanks to the reference ending in TE (eg. F010TE).

- Key head design identical to the original.
- Wide and continuously updated keys range.

🇮🇹 GAMMA CHIAVI SILCA LOOK A-LIKE

GTI è compatibile con la nuova serie di chiavi transponder Silca Look A-like: una gamma di chiavi veicolo con design della testa identica alla chiave originale. Potrai riconoscere facilmente le chiavi della gamma Silca Look A-like per la referenza terminante in TE (es. F010TE).

- Design testa chiave identica all'originale.
- Gamma di referenze ampia e in continuo aggiornamento.

🇩🇪 SCHLÜSSEL SILCA LOOK A-LIKE

GTI kann mit den neuen Silca Look A-Like Transponder Schlüsseln verwendet werden: die Fahrzeugschlüssel mit Kopf-Design entsprechend dem Original-Schlüssel. Die Look A-like Schlüssel sind einfach erkennbar dank den Buchstaben "TE" am Ende der Artikelnummer (z.B. F010TE).

- Dem Original entsprechendes Schlüssel-Kopf-Design.
- Reichhaltig Schlüssel-Sortiment mit dauernder Erweiterung.

🇫🇷 GAMME CLÉS SILCA LOOK A-LIKE

GTI est compatible avec la nouvelle série de clés transpondeur Silca Look A-like: une gamme de clés pour véhicule avec un design de la tête identique à la clé originale. Vous pourrez reconnaître facilement les clés de la gamme Silca Look A-like par la référence, qui terminera avec TE (Ex: F010TE).

- Design tête clé identique à l'originale.
- Gamme de références ample et continuellement mise à jour.

🇪🇸 GAMA LLAVES SILCA LOOK A-LIKE

GTI es compatible con la nueva serie de llaves transponder Silca Look A-like: una gama llaves vehículo con el mismo design de la llave original. Podrá reconocer las llaves de la gama Silca Look A-like a través de la referencia que termina por TE (es. F010TE).

- Design de la cabeza llave idéntico al original.
- Gama referencias amplia y en continua evolución.

🇵🇹 LINHA DE CHAVES SILCA LOOK A-LIKE

O transponder GTI é compatível com a nova linha de chaves transponder Silca Look A-like: uma linha de chaves para veículos com o formato da cabeça igual às chaves originais. Você será capaz de reconhecer a linha de chaves Look A-like graças à referência que acaba sempre em TE (ex.: F010TE).

- Formato da cabeça da chave igual à chave original.
- Ampla linha de chaves, atualizada constantemente.

Transponder components / Componenti Transponder / Transponderkomponenten / Composants Transpondeur / Componentes Transponder / Componentes Transponder

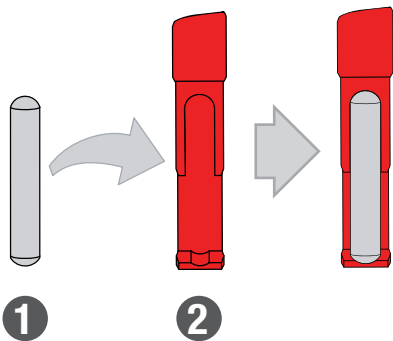

Code / Codice / Código: **C03313**

- | | |
|----------|-------------------------------------------------------------------------------------------------------------------------------------------------------------------------|
| 1 | GTI Transponder
Transponder GTI
Transponder GTI
Transpondeur GTI
Transponder GTI
Transponder GTI |
| 2 | Transponder adapter
Adattatore transponder
Transponder adapter
Adaptateur pour transpondeur
Adaptador para transponder
Adaptador para transponder |

Transponder Key and GTI / Chiave Transponder e GTI / Transponderschlüssel und GTI / Clé Transpondeur et GTI / Llave Transponder y GTI / Chave Transponder e GTI

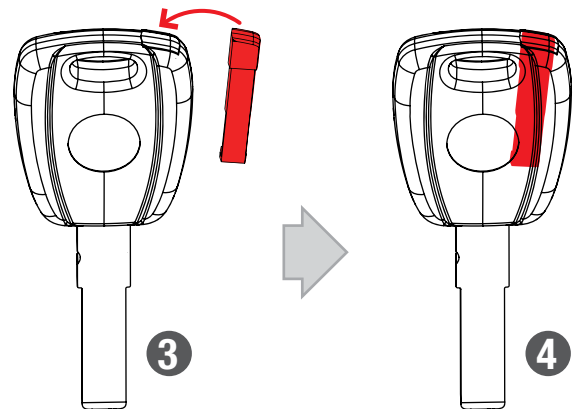

Code / Codice / Código: **SIP22TE**

- | | |
|----------|------------------------------------------------------------------------------------------------------------------------------------------------------------------------------------------------------------------------------------------|
| 3 | Transponder key without GTI
Chiave transponder senza GTI
Transponderschlüssel ohne GTI
Clé transpondeur sans GTI
Llave transponder sin GTI
Chave transponder sem GTI |
| 4 | Transponder key with GTI inside
Chiave transponder con GTI inserito
Transponderschlüssel mit GTI eingefügt
Clé transpondeur avec GTI inséré
Llave transponder con GTI insertado
Chave transponder com GTI inserido |



Look A-like Keys with GTI Transponder

Edition
OCTOBER
2014

BW9TE

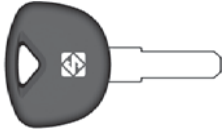

For/Per/Für/Pour/Para:

BMW	
C600 SPORT	2012
C650 GT	2012
F650	2008
F800	2006
G650	2011
K1200	2005
K1300	2009
K1600	2011
R1200	2005

CY24TE



For/Per/Für/Pour/Para:

CHRYSLER	
200	2011
300	1998
300	2005
300	2008
ASPEN	2007
CIRRUS	1999
CIRRUS Convertible	2001
CIRRUS SEDAN	2001
CONCORDE	1998
LHS	1999
NEON	2000
NEW YORKER	1998
PACIFICA	2004
PT CRUISER	2001
PT CRUISER	2006
PT CRUISER LE	2001
SEBRING	2007
SEBRING CONVERT	2001
SEBRING CONVERT	2007
SEBRING SEDAN	1999
STRATUS	1998
TOWN & COUNTRY	2001
TOWN & COUNTRY	2004
VISION	1998
VOYAGER	1998
VOYAGER	2004

DODGE	
AVENGER	2008
CALIBER	2007
CARAVAN	2001
CARAVAN	2004
CHARGER	2005
DAKOTA	2001
DAKOTA	2005
DURANGO	2001
DURANGO	2005
INTREPID	1998
INTREPID SEDAN, ES	2001
MAGNUM	2005
NEON	2000
NITRO	2007
RAM	2002
RAM	2006
STRATUS SEDAN	1998

EAGLE	
VISION	1998

JEEP	
CHEROKEE	1998
CHEROKEE	2005
CHEROKEE LIMITED	1999
CJ5,CJ7	1998
CJ5,CJ7	2006
COMANCHE	2006
COMMANDER	2006
COMPASS	2007
G. CHEROKEE	2005
G. CHEROKEE LUX	1999
G. CHEROKEE SPORT	1998
LIBERTY	2002
LIBERTY	2005
PATRIOT	2007
WRANGLER	1998
WRANGLER	2006

MITSUBISHI	
RAIDER	2006

JEEP	
BREEZE	1999
NEON	2000
PROWLER	2000

STERLING	
BULLET	2008

DAT17TE

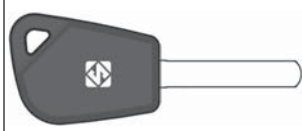

For/Per/Für/Pour/Para:

SUBARU	
B9 TRIBECA	2007
FORESTER	2008
IMPREZA	2007
LEGACY	2004
LEGACY	2005
OUTBACK	2003
OUTBACK	2005

DH5RTE



For/Per/Für/Pour/Para:

DAIHATSU	
CUORE	1998
MOVE	1997

DWO4RTE

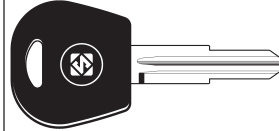

For/Per/Für/Pour/Para:

CHEVROLET-DAEWOO	
AVEO	2006
AVEO	2006
KALOS	2002
LACETTI	2002
LACETTI	2002
LACETTI	2004
LACETTI	2004
NUBIRA	2000
NUBIRA	2000
NUBIRA SW	2004
TACUMA	2000

DWOSTE

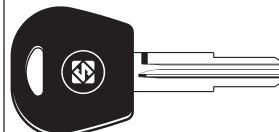

For/Per/Für/Pour/Para:

CHEVROLET-DAEWOO	
CAPTIVA	2006
EPICA	2006
EPICA	2008
EVANDA	2003
LEGANZA	2000

CHEVROLET USA	
CAPTIVA SPORT	2012

OPEL-VAUXHALL	
ANTRA	2007

SATURN (GM)	
VUE	2008

FO10TE

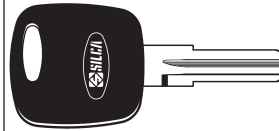

For/Per/Für/Pour/Para:

FORD SUD-AMERICA	
C-MAX	2004
ECO-SPORT	2003
FIESTA MAX	2005
FIESTA	2003

FO19TE

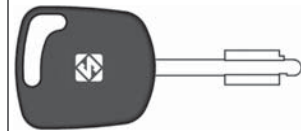

For/Per/Für/Pour/Para:

LDV	
CONVOY	1998
CUB	1998

FO21TE



For/Per/Für/Pour/Para:

FORD AUS	
FALCON	1999
TERRITORY	2004

FORD EU	
CONNECT	2002
COUGAR	1997
COURIER KOMBI	1998
ESCORT	1995
FIESTA	1995
FIESTA	2003
FOCUS	1998
FUSION	2002
KA	1996
KA	2002
MONDEO	1995
MONDEO	2001
PUMA	1998
SCORPIO	1995
TRANSIT	1995
TRANSIT	2000
TRANSIT	2007
TRANSIT	2007

FORD SUD-AMERICA	
FOCUS	1998
KA	2008
MONDEO	2006

FORD USA	
TRANSIT CONNECT	2010

JAGUAR	
S-TYPE	2000
XJ	2003
X-TYPE	2002

MAZDA	
121	1997

FO26TE



For/Per/Für/Pour/Para:

FORD USA	
CONTOUR V6 LX	1998

MERCURY	
COUGAR	1999
MYSTIQUE V6 LS	1997

FO38RTE



For/Per/Für/Pour/Para:

FORD AUS	
ESCAPE	2005
EXPLORER SPORT TRAC	1998
EXPLORER SPORT TRAC	2002
EXPLORER	1998
EXPLORER	2001
EXPLORER	2004
FOCUS	2000
TAURUS LX / SHO	1998
TRIBUTE	2001

FO38RTE

FORD SUD-AMERICA	
RANGER	2004

FORD USA	
HEAVY TRUCKS	2000
CROWN VICTORIA	1998
CROWN VICTORIA	2003
EDGE	2007
EDGE	2007
ESCAPE	2001
ESCAPE	2005
E-SERIES VAN	2008
EXCURSION	2000
EXPEDITION	1997
EXPEDITION	2003
EXPLORER SPORT TRAC	1999
EXPLORER SPORT TRAC	2002
EXPLORER	1998
EXPLORER	2001
EXPLORER	2004
F-150	1998
F-150	2004
F-250	1998
F-250	2004
F-350	1999
F-350	2004
FIVE HUNDRED	2005
FLEX	2009
FLEX	2009
FOCUS	2005
FREESTAR	2004
FREESTYLE	2005
FREESTYLE	2005
FUSION	2006
FUSION	2006
MUSTANG COBRA	1996
MUSTANG GT	1996
MUSTANG	1998
MUSTANG	2005
RANGER XLT V6	1999
RANGER	1999
RANGER	2001
TAURUS LX / SHO	1996
TAURUS	2000
TAURUS	2004
TAURUS	2008
TAURUS	2008
TAURUS	2002
THUNDERBIRD	1999
WINDSTAR	1999
WINDSTAR	2001

LINCOLN	
AVIATOR	2003
BLACKWOOD	2002
CONTINENTAL	1998
CONTINENTAL	2002
LHS	1998
LS	2000
LS	2003
MARK LT	2005
MKX	2007
MKZ	2006
NAVIGATOR	1997
NAVIGATOR	2002
TOWN CAR	1998
TOWN CAR	2003
ZEPHYR	2006

MERCURY	
GRAND MARQUIS	1998
GRAND MARQUIS	2003
MARAUDER	2003
MARINER	2005
MILAN	2006
MONTEGO	2005
MONTEREY	2004
MOUNTAINEER	1998
MOUNTAINEER	2001
SABLE GS, LS	2000
SABLE GS	1999
SABLE LS, SE, SHO	1996

GM45TE

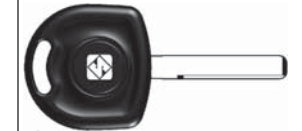

For/Per/Für/Pour/Para:

CHEVROLET USA	
CAPRICE PPV	2011

HOLDEN	
COMMODORE VE	2006

PONTIAC	
G8	2008



Look A-like Keys with GTI Transponder

Edition
OCTOBER
2014

GT10BTE

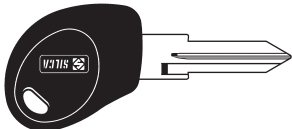

For/Per/Für/Pour/Para:

CITROËN		
JUMPER	1996	2001
RELAY	1996	2001

FIAT		
CINQUECENTO	1995	1996
CROMA	1995	1997
DUCATO	1996	2001
FIORINO	1995	2002
PANDA	1995	2002

IVECO		
35C11	2000	
EUROSTAR	1998	2002
NEW DAILY	1998	
S-2000	1998	

PEUGEOT		
BOXER	1996	2001

GT15RBTE

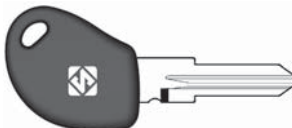

For/Per/Für/Pour/Para:

FIAT		
BRAVA	1995	1996
BRAVO	1995	1996
CINQUECENTO	1997	1998
MARENGO	1996	2001
SEICENTO	1997	2000
TEMPRA	1995	1996

HON58RTE



For/Per/Für/Pour/Para:

ACURA		
RL	2005	2010
TL	2004	2006
TSX	2004	2007

HONDA		
GOLD WING	2001	

HON66TE



For/Per/Für/Pour/Para:

ACURA		
CSX	2006	2011
MDX	2007	2013
RDX	2007	2012
TL	2007	
TSX	2007	
ZDX	2010	2012

HONDA		
RD	2003	2006
ACCORD	2008	
CIVIC	2006	2014
CIVIC (Australia)	2003	
CR-V	2007	2014
CR-Z	2010	
INSIGHT	2009	
JAZZ	2009	
MDX (Australia)	2003	
STREAM	2008	

HON66TE

HONDA USA		
ACCORD	2003	
ACCORD CrossT	2010	
CIVIC	2006	
CR-V	2007	
CR-Z	2011	
ELEMENT	2006	2011
FIT	2009	
INSIGHT	2010	
ODYSSEY	2005	
PILOT	2006	
RIDGELINE	2005	

HON70TE

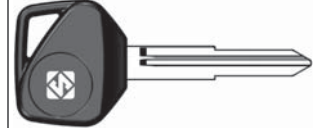

For/Per/Für/Pour/Para:

HONDA		
BLACK SPIRIT	2010	
CBF600	2007	2012
CBR600F	1999	2006
CBR600RR	2003	
CBR900	2003	
CBR1000	2004	
CBR1100XX	1999	2006
CROSSRUNNER	2011	
CROSSSTOURER	2012	
CTX700	2014	
CTX1300	2014	
HORNET	2003	
INTEGRA	2012	
NC700 S	2012	
NC700 X	2012	
NC750	2014	
NT650V	1999	2006
NT700V	2006	2012
SHADOW 750	2004	
SILVER WING	2001	2008
ST1300 Pan-European	2008	
SW-T400	2009	
SW-T600	2011	
VARADERO	2003	
VFR800	2006	
VFR1200	2009	
VT1300CX	2009	
VT750 C4	2004	2010
VTX1800C	2002	
X-ELEVEN	2001	2003

HU43TE



For/Per/Für/Pour/Para:

OPEL-VAUXHALL		
SIGNUM	2003	2005
VECTRA	2002	2005

HU56RTE



For/Per/Für/Pour/Para:

MITSUBISHI		
COLT	2004	
SMART	2004	
FORFOUR	2004	2006

HU66TE

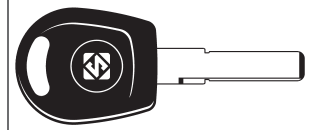

For/Per/Für/Pour/Para:

AUDI		
A8	2004	
PORSCHE		
CAYMAN	2009	

HU71TE

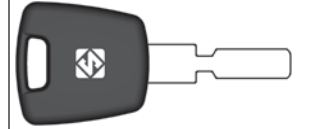

For/Per/Für/Pour/Para:

SCANIA		
164	2004	
R-SERIES	2005	

HU83TE



For/Per/Für/Pour/Para:

CITROËN		
C4 PICASSO	2006	
C5	2008	
C8	2002	
DISPATCH	2007	
JUMPY	2007	

FIAT

SCUDO	2007	
ULYSSE	2002	2011

LANCIA

PHEDRA	2002	2011
--------	------	------

PEUGEOT

207	2006	
208	2012	
307	2001	2009
308	2007	
807	2002	
2008	2013	
3008	2009	
5008	2009	
EXPERT	2007	
RCZ	2010	

HU87RTE

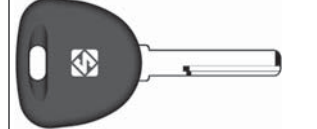

For/Per/Für/Pour/Para:

SUBARU		
G3X JUSTY	2004	2007
SUZUKI		
IGNIS	2000	2005

HU92RTE

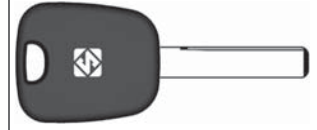

For/Per/Für/Pour/Para:

BMW		
SERIE 1	2004	2011
SERIE 3	2005	2011
SERIE 5	2003	2010
SERIE 6	2004	2011
SERIE 7	2002	2008
X5	2004	2011
Z4	2006	2011
LAND ROVER		
RANGE ROVER	2003	2005

HU100TE



For/Per/Für/Pour/Para:

BUICK		
ALLURE	2010	
ENCORE	2014	

HU100TE

BUICK		
LACROSSE	2010	
REGAL	2011	
VERANO	2012	
CADILLAC		
SRX	2010	
CHEVROLET-DAEWOO		
AVEO	2011	
CRUZE	2009	
MALIBU	2012	
ORLANDO	2011	
TRAX	2013	
VOLT	2012	

CHEVROLET SUD-AMERICA

AGILE	2009	
-------	------	--

CHEVROLET USA

CAMARO	2010	
CRUZE	2011	
EQUINOX	2010	
MALIBU	2013	
ORLANDO	2012	
SONIC	2012	
VOLT	2011	

GMC (GM)

SIERRA	2014	
TERRAIN	2010	

HOLDEN

ASTRA	2004	
VECTRA	2004	
ZAFIRA	2004	

OPEL-VAUXHALL

ADAM	2013	
------	------	--

OPEL-VAUXHALL

AMPERA	2012	
ASTRA	2004	
CABRIO	2013	
CASCADA	2013	
CORSA	2006	
INSIGNIA	2008	
MERIVA	2010	
MOKKA	2012	
SIGNUM	2003	2008
VECTRA	2004	2008
ZAFIRA	2006	

SATURN (GM)

ASTRA	2008	2009
-------	------	------

HU101TE

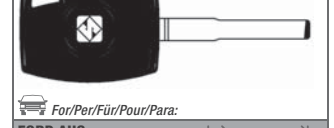

For/Per/Für/Pour/Para:

FORD AUS		
BF FALCON	2005	
TERRITORY	2005	
FORD EU		
FIESTA	2008	2012
FOCUS	2004	2010
FOCUS C-MAX	2003	2010
GALAXY	2006	2010
KUGA	2008	
MONDEO	2007	2010
S-MAX	2006	2010

FORD SUD-AMERICA

MONDEO	2007	
--------	------	--

LAND ROVER

DISCOVERY 3	2006	2009
RANGE ROVER SPORT	2006	2009

HU133RTE



For/Per/Für/Pour/Para:

FIAT		
SEDCI	2006	
MARUTI SUZUKI		

ALTO K10	2010	
A-STAR	2007	
RITZ	2007	
SWIFT	2007	
SX4	2007	
WAGON R	2010	
PIXO	2009	



Look A-like Keys with GTI Transponder

Edition
OCTOBER
2014

HU133RTE

OPPEL-VAUXHALL	→	→
AGILA	2008	

SUZUKI

→	→
ALTO	2009
GRAND VITARA	2008
IGNIS	2003
JIMNY	2002
SPLASH	2008
SWIFT	2005
SX4	2006

HU134TE



For/Per/Für/Pour/Para:

KIA	→	→
VENGA	2010	

HU136TE



For/Per/Für/Pour/Para:

RENAULT-DACIA

→	→
DOKKER	2012
LODGY	2012
SANDERO	2010

HYN6TE



For/Per/Für/Pour/Para:

HYUNDAI

→	→
ACCENT	1999
COUPE	1996
COUPE	2001
ELANTRA	2000
EXCEL	1999
GALLOPER	1999
GETZ	2002
H-1	1999
H-1	2006
INNOVATION	1999
LANTRA	1996
LAVITA	2001
MATRIX	2002
SANTAFE	2002
SANTAMO	2000
SCOUPE	1996
TERRACAN	2001
TIBURON	2001
TUCSON	2005
VERNA	1999

KIA

→	→
MORNING	2006
PICANTO	2004
SPORTAGE	2006

HYN7RTE



For/Per/Für/Pour/Para:

HYUNDAI

→	→
GRANDEUR XG (AUS)	1998
SANTAFE	2000
SONATA	1996
SONATA	1998
SONATA	1998
SONICA	1999
SONICA	1996
SONICA	1999
TRAJET	2000
XG25/XG30	1998
XG300 (CANADA)	1998

HYN7RTE

KIA	→	→
SORENTO	2002	
	2009	

HYN10TE



For/Per/Für/Pour/Para:

HYUNDAI

→	→
ACCENT	1996
ATOS	1997
ATOS PRIME	1999
ATOS PRIME	2002
EXCEL	1996
PONY	1995
VERNA	1996

HYN12TE



For/Per/Für/Pour/Para:

HYUNDAI

→	→
STAREX	1998
	2006

HYN14TE

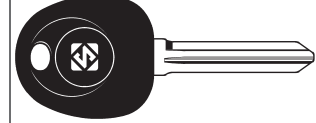

For/Per/Für/Pour/Para:

HYUNDAI

→	→
ENTOURAGE	2007
I10	2008
H-1 BUS	2007

KIA

→	→
CARENS	2006
CARNIVAL	2006
OPTIMA	2006
SEDONA	2006

HYN14RTE



For/Per/Für/Pour/Para:

HYUNDAI

→	→
ELANTRA	2007
GENESIS C.PE	2010
ILOAD	2008
IMAX	2008
SANTAFE	2006
SONATA	2005
VERACRUZ	2007

KIA

→	→
FORTE (CDN)	2008
MAGENTIS	2006
RONDO	2007
SOUL	2009

HYN15TE



For/Per/Für/Pour/Para:

KIA

→	→
RIO	2006
	2009

HYN17BTE



For/Per/Für/Pour/Para:

HYUNDAI

→	→
ACCENT (AUS)	2012
VELOSTER (AUS)	2012

HYN17RBTE



For/Per/Für/Pour/Para:

HYUNDAI

→	→
SANTA FE (AUS)	2013

KIA3RTE



For/Per/Für/Pour/Para:

KIA

→	→
CARENS	2001
CARENS	2001
CARNIVAL	2002
CLARUS	1998
JOICE	2000
MAGENTIS	2001
MENTOR	2002
OPTIMA	2001
RIO	2001
RONDO	2001
SEDONA	2002
SEPHIA	2002
SHUMA	1998
SPORTAGE	1998
SPORTAGE	2001

KW16TE



For/Per/Für/Pour/Para:

KAWASAKI

→	→
NINJA ZX-6R	2006
NINJA ZX-10R	2004
NINJA ZX-12R	2002
NINJA ZX-14R	2006
Z1000	2004
Z750S	2006
ZZR1200	2002
ZZR1400	2007

MAZ24RTE



For/Per/Für/Pour/Para:

MAZDA

→	→
CX-7	2007
CX-9	2007
DEMIO [J]	2003
MAZDA 2	2003
MAZDA 3	2004
MAZDA 5	2005
MAZDA 6	2003
MX-5	2005
RX-8	2004

MIT8TE

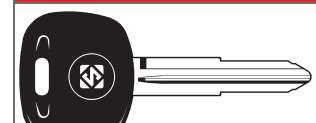

For/Per/Für/Pour/Para:

MITSUBISHI

→	→
CHALLENGER	1999
CHALLENGER	2002
DIAMANTE	2002
ECLIPSE	1996
ECLIPSE	2001
EXPRESS	1996
FOCUS	1998
GALANT	1996
GALANT	2002
L200	2002
L200	2006
MONTERO	1996
MONTERO	2001
MONTERO	2002
MONTERO	2002
MONTERO SPORT	2000
MONTERO SPORT	2001
MONTERO SPORT	2002
NIMBUS	1998
OUTLANDER	2000
PAJERO SPORT	1999
PAJERO SPORT	2002
PAJERO SPORT	2002
PAJERO	1996
PAJERO	2000
PAJERO	2002
PAJERO	2002
PAJERO	2006
SHOGUN SPORT	1999
SHOGUN SPORT	2002
SHOGUN	1996
SHOGUN	2000
SHOGUN	2002
SHOGUN	2002
SHOGUN	2002
SPACE GEAR	1996
SPACE RUNNER	1998
SPACE WAGON	1998
SPACE WAGON	1999
VERADA	2002

MIT11RTE



For/Per/Für/Pour/Para:

CITROËN

→	→
C-CROSSER	2007
C-ZERO	2011

MITSUBISHI

→	→
380	2006
COLT	1996
ECLIPSE	2008
ENDEAVOR	2007
GALANT (USA)	2008
GALANT	2006
GRANDIS	2003
I-MIEV	2010
LANCER SW	1996
LANCER	1996
LANCER	2003
LANCER	2006
MIRAGE	1996
MIRAGE	2014
MONTERO IO	2000
OUTLANDER	2004
OUTLANDER	2006
PAJERO IO	1999
PAJERO MINI [J]	1999
PAJERO PININ	1999
PAJERO PININ	2004
SHOGUN PININ	1999

PEUGEOT

→	→
4007	2007
ION	2011



Look A-like Keys with GTI Transponder

Edition
OCTOBER
2014

NE72ATE

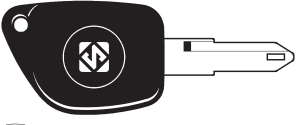

For/Per/Für/Pour/Para:

NISSAN		
INTERSTAR	2002	2010
PRIMASTAR	2003	
OPEL-VAUXHALL		
MOVANO	2002	2010
VIVARO	2002	
RENAULT		
CLIO II	2001	2012
MASTER	2002	2010
THALIA	2001	2008
TRAFIC	2002	
RENAULT-DACIA		
SYMBOL	2010	
SYMBOL	2010	2013

NE73TE



For/Per/Für/Pour/Para:

NISSAN		
INTERSTAR	2002	2010
OPEL-VAUXHALL		
MOVANO	2002	2010
PEUGEOT		
106	2000	2004
206	2001	2009
206 Cabrio	2002	2007
206 PLUS	2009	
RENAULT		
AVANTIME	2001	2003
MASTER	2002	2010
MEGANE	1998	2000
MEGANE	2000	2003

NE75TE



For/Per/Für/Pour/Para:

LAND ROVER		
FREELANDER	2003	2006

NE78TE



For/Per/Für/Pour/Para:

PEUGEOT		
406	2002	2004
607	2004	2010

NSN11TE

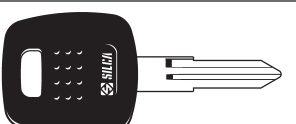

For/Per/Für/Pour/Para:

NISSAN		
ATLEON	2002	
CAB STAR	2000	2003
CAB STAR	2003	2007
MICRA MARCH [J]	2000	2003
MICRA VAN	2000	2003
MICRA	2000	2003
TERRANO II	2002	2006

NSN11TE

NISSAN		
VANETTE CARGO	2000	
VANETTE	2000	

NSN14TE



For/Per/Für/Pour/Para:

INFINITI		
FX35	2003	2009
FX45	2003	2009
G20	2000	2002
G35	2003	2007
I30	2001	2004
I35	2001	2004
M35	2003	2004
M45	2003	2006
Q45	1997	2000
Q45	2001	2005
QX4	1997	1999
QX4	1999	2003
QX56	2004	2007

NISSAN

ALMERA TINO	2000	2003
ALMERA TINO	2004	2006
ALMERA	2000	2003
ALMERA	2003	2006
JUKE	2010	
MICRA	2003	
MURANO	2003	2007
NAVARA	2003	2005
NAVARA	2003	2005
NAVARA	2005	
NOTE	2006	2012
NP300	2010	
PATHFINDER	2005	
PATROL	2004	
PRIMERA	1998	2000
PRIMERA	2002	2008
PULSAR	1998	2000
QASHQAI	2007	2013
X TERRA	2000	2004
X-TRAIL	2001	2003
X-TRAIL	2004	

NISSAN USA

350Z	2003	2009
ALTIMA	2005	2006
ARMADA	2004	
CUBE	2009	2013
FRONTIER	2002	2005
FRONTIER	2005	
JUKE	2011	
LIVINA	2007	
MAXIMA	2000	2003
MAXIMA	2004	2007
MURANO	2003	2008
N1 Series	2012	
PATHFINDER	2005	
QUEST	2004	2010
ROGUE	2007	
SENTRA	2007	
TIDA	2007	
TITAN	2004	
VERSA	2007	
X TERRA	2005	2013
X-TRAIL	2005	2006

SUBARU

FORESTER	1998	2003
IMPENZA	1998	2003
LEGACY	1998	2003
OUTBACK	1998	2003

SUZUKI

EQUATOR	2009	
---------	------	--

NSN19TE

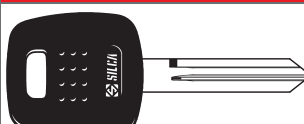

For/Per/Für/Pour/Para:

NISSAN		
CAB STAR	2007	
RENAULT		
MAXITY	2007	
SUBARU		
B9 TRIBECA	2006	2011
BAJA	2005	2007

NSN19TE

SUBARU		
FORESTER (AUS)	1998	2004
FORESTER	2004	2007
IMPENZA (AUS)	1998	2004
IMPENZA	2004	2007
LIBERTY (AUS)	1998	2003
OUTBACK (AUS)	1998	2003

PO1RTE



For/Per/Für/Pour/Para:

PROTON		
415	1996	1998
416	1996	1998

SIP16TE



For/Per/Für/Pour/Para:

ALFA ROMEO		
166	2000	2004

SIP22TE



For/Per/Für/Pour/Para:

ABARTH		
GRANDE PUNTO	2007	2010
PUNTO	2012	
PUNTO EVO	2010	2012
500	2008	
ALFA ROMEO		
GIULIETTA	2010	
MITO	2008	
156	2001	2003
156 SPORT WAGON	2001	2007
166	2004	2008

CITROËN

JUMPER	2006	
NEMO	2008	
RELAY	2006	

FIAT

BRAVO	2007	
DOBLO'	2006	
DUCATO	2006	
FIORINO	2007	
GRANDE PUNTO	2005	
IDEA	2009	
PANDA	2002	
PUNTO	2012	
PUNTO EVO	2009	2012
QUBO	2008	
500	2007	
500L	2012	

FORD EU

KA	2009	
----	------	--

IVECO

EURO CARGO	2002	2007
STRALIS	2002	2007

LANCIA

DELTA	2008	
MUSA	2009	
YPSILON	2011	

PEUGEOT

BIPPER	2009	
BOXER	2006	

SSY3TE



For/Per/Für/Pour/Para:

SSANGYONG		
ACTYON	2007	
KYRON	2005	
REXTON	2006	

SX9TE



For/Per/Für/Pour/Para:

CITROËN		
BERLINGO	2001	2002
C5	2000	2004
DISPATCH	2002	2006
JUMPY	2002	2006
SAXO	2000	2003
XSARA	2001	2006
XSARA PICASSO	2000	2006
FIAT		
SCUDO	2002	2006
PEUGEOT		
EXPERT	2002	2006
PARTNER	2001	2002
RANCH	2001	2002

SZ11TE

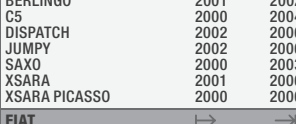

For/Per/Für/Pour/Para:

MARUTI SUZUKI		
ALTO	2007	2010
SUZUKI		
ALTO	2002	2008

SZ11RTE

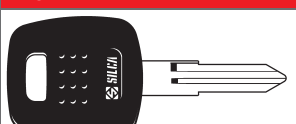

For/Per/Für/Pour/Para:

MARUTI SUZUKI		
VERSA	2007	2010
WAGON R	2007	2010
ZEN ESTILO	2007	2010
SUZUKI		
ALTO	1996	2002
ALTO	2002	2008
BALENO	1996	2001
ESCUDO [J]	1996	2002
GRAND VITARA	1996	2002
GRAND VITARA	2002	2008
IGNIS	2000	2008
JIMNY	1999	2002
JIMNY	2002	
SWIFT	1996	2005
VITARA	1996	2002
VITARA	2002	2008
WAGON R	1998	2000

SZ12TE



For/Per/Für/Pour/Para:

SUZUKI		
ALTO	1996	2002
ALTO	2002	2008
BALENO	1996	2001
ESCUDO [J]	1996	2002
GRAND VITARA	1996	2002
GRAND VITARA	2002	2008
IGNIS	2000	2008
JIMNY	1999	2002
JIMNY	2002	
SWIFT	1996	2005
VITARA	1996	2002
VITARA	2002	2008
WAGON R	1998	2000

SZ12TE

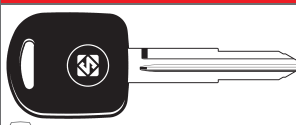

For/Per/Für/Pour/Para:

ISUZU		
BIG HORN	1998	2002
TROOPER	1998	2002
SUBARU		
JUSTY	1996	2003

SZ12TE

SUZUKI	→	→
ALTO	1996	2002
BALENO	1996	2001
ESCUDO [J]	1996	2002
GRAND VITARA	1996	2002
SWIFT	1996	2005
VITARA	1996	2002

SZ17RTE



For/Per/Für/Pour/Para:

SUZUKI	→	→
GSF BANDIT	2007	
GSR600	2007	
GSX1300 HAYABUSA	2007	
GSX-R1000	2006	
GSX-R600	2006	
GSX-R750	2006	
V-STROM	2007	

SZ18TE



For/Per/Für/Pour/Para:

MARUTI SUZUKI	→	→
800	2007	2010

SZ18RTE



For/Per/Für/Pour/Para:

MARUTI SUZUKI	→	→
ESTEEM	2007	
OMNI	2007	2010

SZ22TE



For/Per/Für/Pour/Para:

SUZUKI	→	→
GRAND VITARA	2006	2008
LIANA	2001	2005
LIANA	2006	2007
SWIFT	2005	

TAT1TE

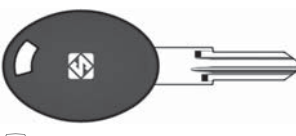

For/Per/Für/Pour/Para:

TATA	→	→
ARIA	2010	
INDICA	2008	
INDIGO	2008	
MANZA	2009	

TOY40BTE



For/Per/Für/Pour/Para:

LEXUS	→	→
CELSIOR [J]	1997	
ES300	1998	2001
LAND CRUISER [J]	1999	
LS400	1997	2000
LX450	1998	
LX470	1999	2000
SC300/400	1998	2003

MITSUBISHI	→	→
MAGNA	1999	2005
VERADA (AUS)	2000	2002

TOYOTA	→	→
LAND CRUISER	1998	2000
CELSIOR	1998	2004

TOYOTA JAPAN	→	→
CELSIOR	1998	2004

TOY41RATE

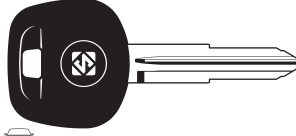

For/Per/Für/Pour/Para:

TOYOTA JAPAN	→	→
PLATZ	1999	2002

TOYOTA	→	→
ECHO	1999	2005

TOY41RTE

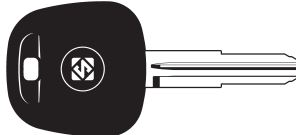

For/Per/Für/Pour/Para:

DAIHATSU	→	→
CHARADE	1998	2004
COPEL	2002	
CUORE	1998	2006
CUORE	2007	
FEROZA	1995	1998
MATERIA	2006	
SIRION	1998	2004
SIRION	2005	
TERIOS	1997	2005
TERIOS	2006	
TREVIS	2007	
YRV	2000	2005

TOYOTA	→	→
MR2	1997	2007
YARIS	1999	2005

TOYOTA USA	→	→
MR2	2001	2005

TOY43ATE

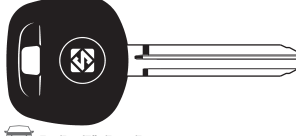

For/Per/Für/Pour/Para:

PONTIAC	→	→
VIBE	2009	2010

SCION	→	→
TC	2005	2010
XA	2004	2007
XB	2004	2008
XD	2008	2012

TOY43ATE

TOYOTA	→	→
4RUNNER	1999	2002
ALPHARD	2005	
AURION (AUS)	2006	
AURIS	2006	
AVENSIS VERSO	2001	2003
CAMRY	1996	2005
CAMRY	2006	
CELICA	2000	2005
COROLLA	2007	
ECHO VERSO	2002	2005
FJ CRUISER	2007	
FORTUNER	2007	
HIACE	1995	2006
HIACE	2007	
HILUX	1999	2004
HILUX	2005	
INNOVA KIJANG	2005	
iQ	2008	
LAND CRUISER 90	1996	2002
LAND CRUISER 100	1998	2002
LAND CRUISER 100	2003	
LAND CRUISER 120	2002	
LAND CRUISER PRADO	2002	
PICNIC	1996	2003
PICNIC	2003	2008
PREVIA	2000	2003
PREVIA	2003	2008
PRIUS	2000	2003
RAV 4	2005	2010
REIZ	2005	
T.U.V.	2003	
TARAGO	2003	2008
VIOS	2007	
WISH	2004	

TOYOTA JAPAN	→	→
ALPHARD	2003	
db	2000	2005
CALDINA	2002	2004
COROLLA FIELDER	2004	
COROLLA RUNX	2004	
COROLLA SPACIO	2003	
DYNA	2008	
ESTIMA	2001	2003
ESTIMA	2003	
FUN CARGO	2003	2005
GAIA	1999	2004
GAIA	1996	2003
IPSUM	2003	
IPSUM	2003	
ISIS	2003	
IST	2003	
KLUGER	2001	2003
KLUGER	2003	
LAND CRUISER PRADO	2000	2002
LAND CRUISER PRADO	2002	2005
MARK 2	2000	2006
MARK X	2004	
NOAH	2004	
OPEN DECK	2000	2005
IPSUM	1996	2005
PLATZ	2003	2002
PRONARD	2000	
RAUM	2003	
RAV 4	2003	
REGIUSACE	2007	
SIENTA	2003	
TOYOACE	2008	
VANGUARD	2005	2004
VEROSSA	2001	
VITZ	2003	
VOXY	2004	
WISH	2003	

TOYOTA USA	→	→
4RUNNER	1999	2002
4RUNNER	2003	2010
AVALON	1998	2004
AVALON	2005	2011
AVANZA	2004	
CAMRY	1998	2004
CAMRY	2003	2010
COROLLA	2005	2010
FJ CRUISER	2007	2010
HIACE	2006	
HIGHLANDER	2001	2003
HIGHLANDER	2004	2010
LAND CRUISER	1998	2002
LAND CRUISER	2003	2008
MATRIX	2005	2010
PRIUS	2001	2003
PRIUS	2004	2008
PRIUS	2006	2010
RAV 4	2006	2010
SEQUOIA	2001	2002
SEQUOIA	2003	2010
SIENNA	1999	2003
SIENNA	2004	2010
SOLARA	2002	2003
SOLARA	2004	2010
TACOMA	2005	2010
TUNDRA	2005	2010
VENZA	2009	2010
YARIS	2007	2011

TOY43RATE

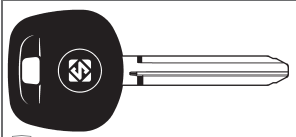

For/Per/Für/Pour/Para:

HOLDEN	→	→
COLORADO	2008	

ISUZU	→	→
D-MAX	2007	

TOY43TE

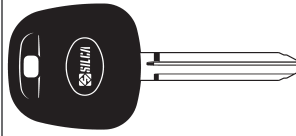

For/Per/Für/Pour/Para:

TOYOTA	→	→
COROLLA	1996	2006
RAV 4	1996	2004

TOY46RTE

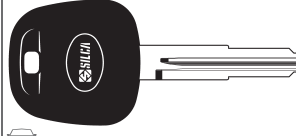

For/Per/Für/Pour/Para:

TOYOTA	→	→
COROLLA	1996	1999

TOY47TE

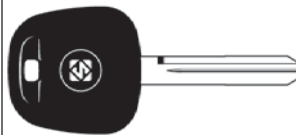

For/Per/Für/Pour/Para:

DAIHATSU	→	→
CHARADE	2011	

TOYOTA	→	→
AURIS (EU)	2007	
AVENSIS	1998	2000
AVENSIS	2000	2003
AVENSIS	2003	
CARINA	1996	2000
COROLLA (S.Africa)	2008	
COROLLA	1999	2006
YARIS	1999	2005
YARIS	2005	2011

TOY48BTE

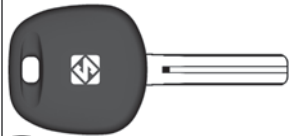

For/Per/Für/Pour/Para:

LEXUS	→	→
ALTEZZA [J]	1999	
ES300	2002	2003
ES330	2004	2007
GS/LS/LX	1998	
GS300	1998	2005
GS300	2005	2007
GS300/400 [J]	1998	
GS400	1998	2001
GS430	2001	2005
GS430	2005	2007
GX470	2003	2007
IS200	1999	2005
IS300	2001	2005
LS200	1999	
LS400	1999	2003
LS430	2001	2006
LX470	2001	2002
LX470	2003	2008
RX300	1999	2003
RX330	2004	2009



Look A-like Keys with GTI Transponder

Edition
OCTOBER
2014

TOY48BTE

LEXUS	↳	→
RX350	2004	2011
RX400h	2005	2009
RX450h	2010	
SC430	2002	2010
TOYOTA	↳	→
LAND CRUISER 100	2000	2002
LAND CRUISER 100 (AUS)	2003	
TOYOTA JAPAN	↳	→
ARISTO	1998	2005
BREVIS	2001	2007
CELSIOR	1998	2004
CROWN	1999	2005
LAND CRUISER PRADO	2000	2002
ORIGIN	2000	
PROGRES NC300	1998	2006
WINDOW	2001	2004

TOY49TE



For/Per/Für/Pour/Para:

HYUNDAI	↳	→
I20	2008	
I30	2007	2011
I40 (AUS)	2010	
I45	2009	
IX20	2010	
IX35	2010	
KIA	↳	→
BORREGO	2009	2011
MAGENTIS	2009	2011
OPIRUS	2007	2010
RIO	2010	2011

VA2TE



For/Per/Für/Pour/Para:

SMART	↳	→
FORTWO	2009	

VAC102TE



For/Per/Für/Pour/Para:

RENAULT	↳	→
KANGOO	2002	2010
TWINGO	2002	2007
RENAULT-DACIA	↳	→
DUSTER	2010	2013
LOGAN	2006	2012
SANDERO	2008	2013

YH35RATE

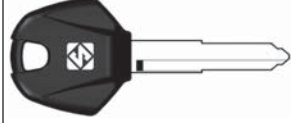

For/Per/Für/Pour/Para:

YAMAHA	↳	→
BT1100 BullDog	2005	
FJR1300	2005	
FZ1	2006	

YH35RATE

YAMAHA	↳	→
FZ6	2004	2011
FZ8	2010	
FZS1000 FAZER	2005	
Majesty 400	2005	
MT-01	2005	2012
MT-03	2006	
TDM600	2005	
T-MAX 500	2005	2012
XJR 1300	2004	
XT660Z Ténéré	2008	
XT1200Z Super Ténéré	2010	
XTR	2004	
XTX	2004	
XVS650A DragStar	2004	2006
XVS1100A DragStar	2004	
YZF-R1	2005	
YZF-R6	2003	

ZD24RTE

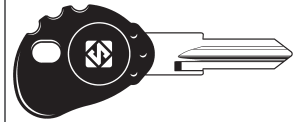

For/Per/Für/Pour/Para:

HONDA	↳	→
SH300	2007	
TRIUMPH	↳	→
TIGER	2010	
YAMAHA	↳	→
X-MAX 125	2006	

↳ In production from year... / Fabricata dall'anno... / Hergestellt seit Jahr... / Fabriqué à partir de l'année... / Fabricada desde el año... / Em produção do ano...
 → In production until year... / Fabricata fino all'anno... / Hergestellt bis Jahr... / Fabriqué jusqu'à l'année... / Fabricada hasta el año... / Em produção até ano...



Look A-like Keys with GTI Transponder

Edition
OCTOBER
2014

EN IMPORTANT

In compliance with current regulations relating to industrial property, we hereby state that the trade-marks or trade names mentioned in our catalogue are the exclusive property of authorized manufacturers of locks and users. Said trade-marks or trade names are nominated only for the purposes of information so that any lock for which our keys are made can be rapidly identified. This catalogue is reserved exclusively for professional key cutters who use Silca products.

All information and illustrations in this catalogue are for guidance only. Silca reserves the right to alter products designs, dimensions or info to improve the products quality. The contents of this catalogue are fully protected by Copyright and may not be copied or reproduced in any form, without written permission from Silca. Any infringements will be dealt with under Italian law.

IT IMPORTANTE

In conformità alle disposizioni legali in vigore relative alle proprietà industriali, informiamo che i marchi o le denominazioni commerciali citate nel nostro catalogo sono di proprietà esclusiva dei fabbricanti di serrature e degli utilizzatori autorizzati. Questi marchi o denominazioni commerciali sono indicati a titolo di semplice informazione, con lo scopo di riconoscere velocemente a quali serrature le nostre chiavi sono destinate. Questo catalogo è esclusivamente riservato ai professionisti della riproduzione chiavi che utilizzano i prodotti Silca.

Le illustrazioni e i dati tecnici dei prodotti contenuti nel catalogo debbono considerarsi indicativi. Silca si riserva il diritto, ferme restando le caratteristiche essenziali dei prodotti, di apportare tutte le modifiche che ritiene necessarie e opportune al fine di migliorare la qualità dei prodotti. Tutti i disegni e le fotografie sono di proprietà di Silca, ogni riproduzione anche parziale, senza autorizzazione scritta della Silca è vietata secondo termini di legge. Per qualsiasi controversia competenti sono gli Uffici Giudiziari dove ha sede l'Azienda, con espressa esclusione di qualsiasi altro foro.

DE WICHTIG

Gemäß den derzeit geltenden Normen bezüglich des Industrieigentums teilen wir Ihnen mit, daß die im vorliegenden Katalog angeführten Markennamen oder Handelsmarken ausschließliches Eigentum der Schloßhersteller und zugelassenen Fachhändler sind. Diese Markenbezeichnungen oder Handelsmarken sind nur zur Information angeführt, mit dem Zweck, schnell erkennen zu können, zu welchem Schloß unsere Schlüssel gehören. Der vorliegende Katalog ist ausschließlich an Schlüsselkopier-Fachgeschäfte, die Silca Produkte benutzen, gerichtet.

Die Abbildungen und technischen Daten des Katalogs sind nur zur Information. Silca behält sich vor, etwaige Änderungen am Produkt, die zur Verbesserung desselben beitragen vorzunehmen. Alle Zeichnungen und Fotos sind Besitz der Firma Silca, jede Reproduktion, auch teilweise, ist ohne schriftliche Erlaubnis der Firma Silca gesetzlich untersagt. Im Falle von Streitfragen ist der Gerichtshof des Firmensitzes zuständig; jeder andere Gerichtshof ist ausgeschlossen.

FR IMPORTANT

Conformément aux lois en vigueur concernant la propriété industrielle, nous vous informons que les marques et appellations commerciales citées dans notre catalogue appartiennent exclusivement aux fabricants de serrures et aux utilisateurs autorisés. Ces marques ou appellations commerciales sont indiquées à titre d'information pure et simple pour vous permettre de déterminer rapidement les serrures auxquelles nos clés sont destinées. Ce catalogue est réservé exclusivement aux professionnels du taillage de clés qui utilisent les produits Silca.

Les illustrations et les caractéristiques techniques des produits présentés dans ce catalogue sont données à titre indicatif. Bien que les caractéristiques essentielles des produits soient invariables, Silca se réserve le droit d'apporter toutes les modifications qu'elle retiendra nécessaires et opportunes afin d'améliorer la qualité de ses produits. Tous les dessins et photos sont propriété Silca et toute reproduction, même partielle, sans l'autorisation écrite préalable de Silca est interdite conformément aux prescriptions légales. Tout litige est du ressort exclusif des Tribunaux de la circonscription où se trouve le Siège de la Société.

ES IMPORTANTE

Conformément aux lois en vigueur concernant la propriété industrielle, nous vous informons que les marques et appellations commerciales citées dans notre catalogue appartiennent exclusivement aux fabricants de serrures et aux utilisateurs autorisés. Ces marques ou appellations commerciales sont indiquées à titre d'information pure et simple pour vous permettre de déterminer rapidement les serrures auxquelles nos clés sont destinées. Ce catalogue est réservé exclusivement aux professionnels du taillage de clés qui utilisent les produits Silca.

Les illustrations et les caractéristiques techniques des produits présentés dans ce catalogue sont données à titre indicatif. Bien que les caractéristiques essentielles des produits soient invariables, Silca se réserve le droit d'apporter toutes les modifications qu'elle retiendra nécessaires et opportunes afin d'améliorer la qualité de ses produits. Tous les dessins et photos sont propriété Silca et toute reproduction, même partielle, sans l'autorisation écrite préalable de Silca est interdite conformément aux prescriptions légales. Tout litige est du ressort exclusif des Tribunaux de la circonscription où se trouve le Siège de la Société.

PT IMPORTANTE

Em conformidade com as disposições legais em vigor relativas à propriedade industrial, informamos que as marcas ou as denominações comerciais citadas no nosso catálogo são propriedade exclusiva dos fabricantes de fechaduras e dos utilizadores autorizados. Estas marcas ou denominações comerciais são indicadas só a nível de informação, a fim de reconhecer rapidamente a quais fechaduras se destinam as nossas chaves. Este catálogo é reservado exclusivamente aos profissionais da reprodução de chaves que utilizam os produtos Silca.

As ilustrações e as características técnicas dos produtos apresentados neste catálogo são facultados a título indicativo. Mesmo que as características essenciais dos produtos sejam invariáveis, à Silca reserva-se o direito de modificar ser necessário e oportuno los productos, afim de melhorar a sua qualidade. Todos os desenhos e fotos são propriedade da Silca, e é proibida a sua reprodução mesmo parcial sem a autorização escrita da Silca conforme as prescrições legais. Em caso de litígio fica desde já designado, excluindo qualquer outro, o Tribunal da comarca onde está registada a sede da Silca.